

# Al volo

Design  
MM Design



**Al volo** è l'ultima innovazione di Ifi per proporre il gelato artigianale, la pasticceria e la pralineria oltre i confini dei punti vendita tradizionali. **Al volo** è una mini vetrina professionale refrigerata, che in uno spazio ridotto racchiude tutto il sapere tecnologico di Ifi. La refrigerazione ventilata garantisce un gelato sempre spatolabile, e i vetri camera riscaldati evitano la formazione di condensa persino in condizioni climatiche estreme, per offrire sempre la massima visibilità dell'alimento, anche da lontano.

Come in ogni progetto Ifi, l'attenzione all'ergonomia è centrale: la maniglia di apertura ambidestra consente un utilizzo ancora più pratico e confortevole, mentre lo sportello posteriore servo-assistito agevola le operazioni di servizio e limita allo stesso tempo la fuoriuscita di aria fredda.

**Al volo** is Ifi's latest innovation to offer artisanal gelato, pastry and pralines beyond the boundaries of traditional shops. **Al volo** is a mini refrigerated professional display case, which in a small space contains all the technological knowledge of Ifi. The ventilated refrigeration guarantees an always spreadable gelato, and the heated double glasses avoid the formation of condensation even in extreme climatic conditions, to always offer the maximum visibility of the food, even from a distance.

As in any Ifi project, attention to ergonomics is central: the ambidextrous opening handle allows even more practical and comfortable use, while the servo-assisted rear door facilitates service operations and limits cold air dispersion to the outside.





## Caratteristiche tecniche e finiture Technical features and finishes

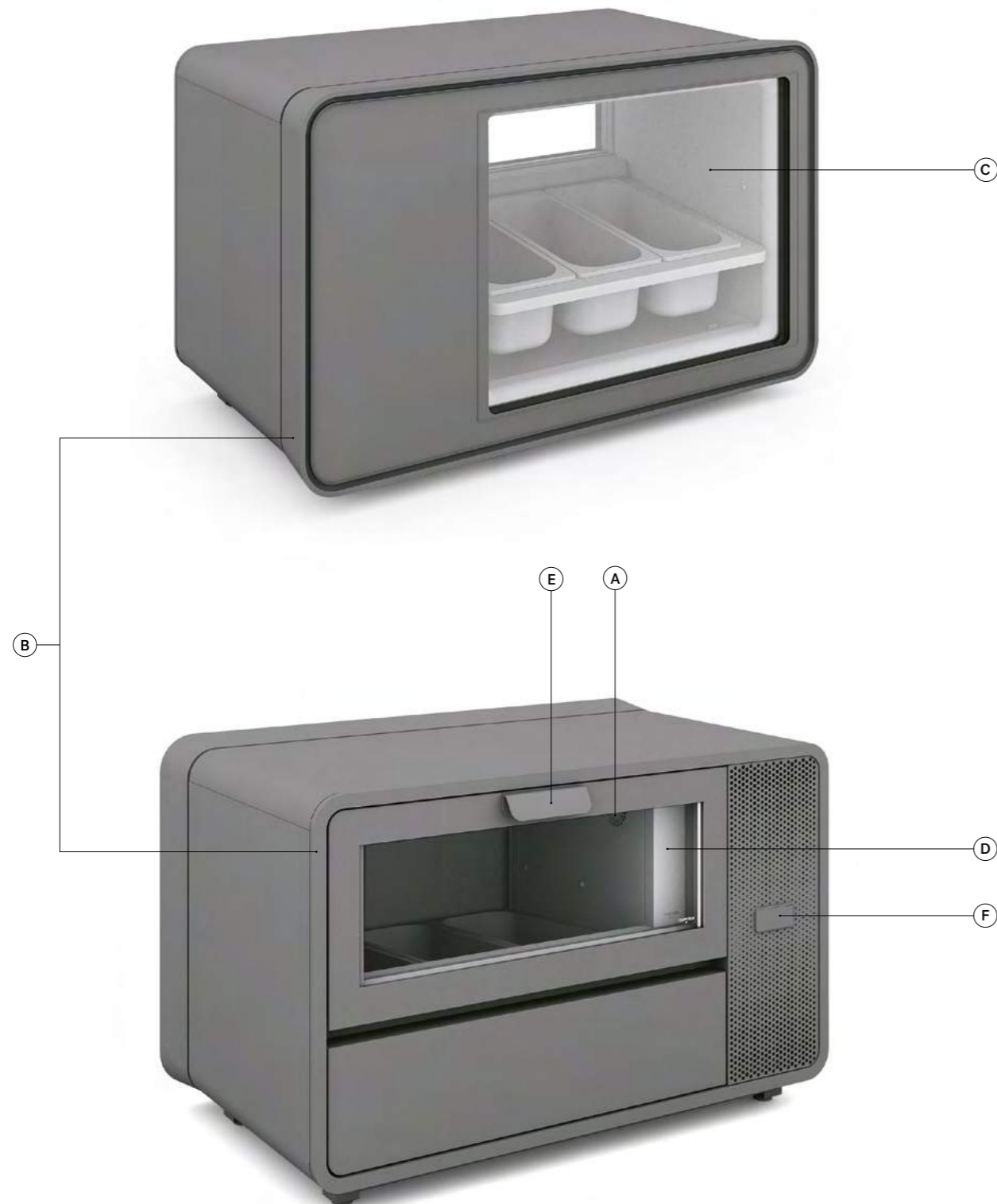

- Ⓐ Refrigerazione ventilata per una temperatura uniforme e un gelato sempre spatolabile.  
Ventilated refrigeration for homogeneous temperature and an always spreadable gelato.
- Ⓑ Cornice anteriore e posteriore in Baydur verniciato bianco.  
Front and rear frame in white painted Baydur.
- Ⓒ Vetro frontale camera riscaldato fisso.  
Fixed heated double front glass.
- Ⓓ Sportello di apertura in vetro camera riscaldato con sistema di chiusura servo-assistita a ritorno automatico.  
Heated double glass opening door with automatic return servo-assisted closing system.

- Ⓔ Maniglia centrale in alluminio anodizzato.  
Central handle in anodized aluminium.
- Ⓕ Display elettronico di ultima generazione con ripetitore di temperatura full touch, resistente all'acqua e alla polvere.  
Latest generation electronic display with full touch temperature repeater, water and dust resistant.



Predisposto per Set for  
Ifi IoT Remote Manager



La cornice in Baydur e l'illuminazione del cielo led integrata contribuiscono a rendere protagonista il prodotto esposto.

The Baydur frame and the integrated ceiling LED lighting make displayed food the undisputed protagonist.



L'apertura lato operatore servo-assistita con maniglia ambidestra e ritorno automatico migliora l'ergonomia e limita la dispersione di aria verso l'esterno, a tutela del prodotto conservato e a vantaggio del risparmio energetico.

The servo-assisted operator's side opening fitted with ambidextrous handle and automatic return improves ergonomics and limits air dispersion towards the outside, to protect the preserved product and promote energy savings.





**SERVIZI SERVICES**

**Gelato -2° / -18°C**  
Gelato 28.40° / -0.40°F

**Pasticceria +4° / +8°C**  
Pastry 39.20° / 46.40°F

**Praliniera con C.U. +14° / +18°C**  
Praline with H.C. 57.2° / 64.4°F

**Classe climatica 4 (30°C - 55% U.R.)**  
Climate class 4 (86°F - 55% R.H.)

**COLORI COLOURS**



**Cornice frontale bianco RAL 9016**  
Front frame white RAL 9016



**Lamiera verniciata grigio RAL 7035**  
Coated sheet metal grey RAL 7035

**DIMENSIONI DIMENSIONS**

mm inches

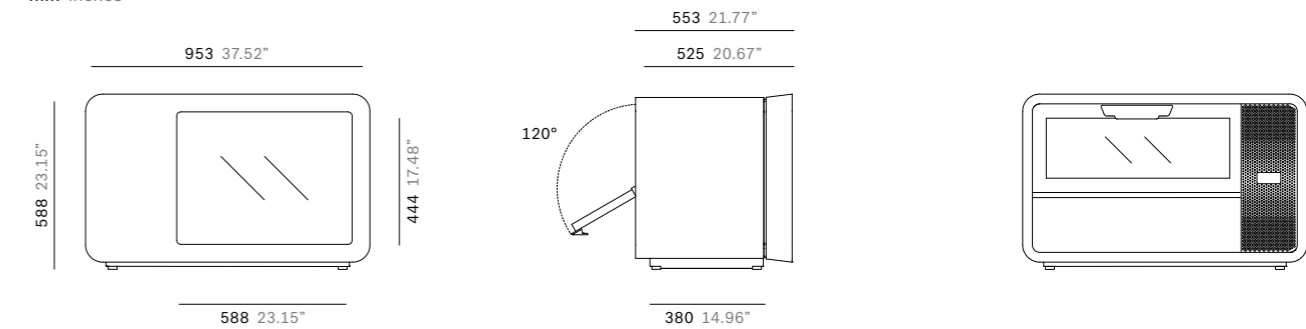

**VASCHETTE GELATO GELATO PANS**

mm inches

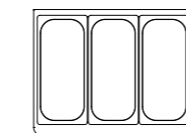

**N.3**  
360x165x120h mm

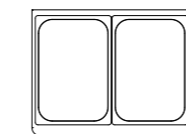

**N.2**  
360x250x120h mm

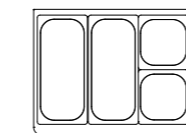

**N.2**  
360x165x120h mm  
**N. 2**  
180x165x120h mm

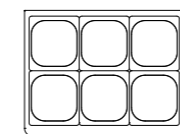

**N.6**  
180x165x120h mm

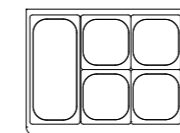

**N.1**  
360x165x120h mm  
**N. 4**  
180x165x120h mm

**VASSOI TRAYS**

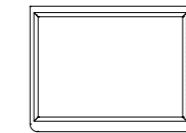

**Vassoio torte**  
467x330 mm  
Cake tray  
467x330 mm

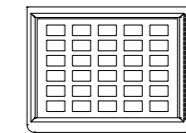

**Vassoio per gelato su stecco**  
Gelato on a stick tray

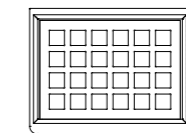

**Vassoio per monoporzioni quadrate**  
Squared-based monoportion tray

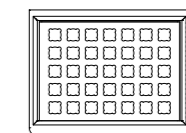

**Vassoio per monoporzioni tonde**  
Round-based monoportion tray